



Document # 13-52-15	Title: QMC6308 Preliminary Datasheet	Rev: B
Originator: ASIC/ Steven Ye		

REVISION RECORD

Rev.	Date	Change Description
A	03/19/2019	Preliminary Version
B	04/01/2019	1) Add Register block definition 2) Change the linearity condition 3) Change top and bottom view pad name 4) Delete the RNG<1:0> definition 5) Delete the TS block definition and TS referred register output 6) Change the DRDY clear condition 7) Delete the NVM_DRY and OTP_LOAD_DONE register definition 8) Adjust the ODR setting, only keep 200Hz/100Hz 9) Change resolution value



Document #: 13-52-15

Title: QMC6308 Preliminary Datasheet

Rev: B



CONTENTS

CONTENTS.....	3
1 INTERNAL SCHEMATIC DIAGRAM.....	4
1.1 Internal Schematic Diagram	4
2 SPECIFICATIONS AND I/O CHARACTERISTICS	5
2.1 Product Specifications	5
2.2 Absolute Maximum Ratings	5
2.3 I/O Characteristics	5
3 PACKAGE PIN CONFIGURATIONS.....	6
3.1 Package 3-D View	6
3.2 Package Outlines	6
4 EXTERNAL CONNECTION.....	8
4.1 Recommended external connection	8
4.3 Mounting Considerations	8
4.4 Layout Considerations	8
5 BASIC DEVICE OPERATION.....	9
5.1 Anisotropic Magneto-Resistive Sensors	9
5.2 Power Management	9
5.3 Power On/Off Time	9
5.4 Communication Bus Interface I ² C and Its Addresses	10
5.5 Internal Clock	10
6 MODES OF OPERATION	10
6.1 Modes Transition	10
6.2 Description of Modes	11
7 Application Examples	12
7.1 Continuous Mode Setup Example	12
7.2 Measurement Example	12
7.3 Standby Example	12
7.4 Soft Reset Example	12
8 I ² C COMMUNICATION PROTOCOL.....	12
8.1 I ² C Timings	12
8.2 I ² C R/W Operation	13
9 REGISTERS	14
9.1 Register Map	14
9.2 Register Definition	14

1 INTERNAL SCHEMATIC DIAGRAM

1.1 Internal Schematic Diagram

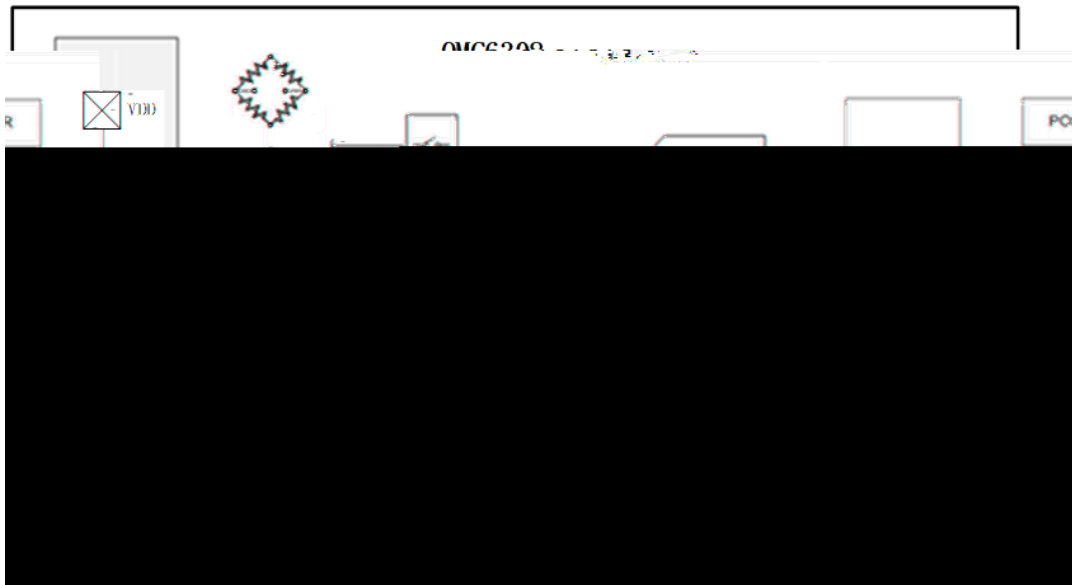

Figure 1. Block Diagram

Table 1. Block Function

Block	Function
AMR Bridge	3-axis magnetic sensor
MUX	Multiplexer for sensor channels
PGA	Programmable gain amplifier for sensor signals
ADC	Analog-to-Digital converter
Signal Conditioning	Digital blocks for magnetic signal calibration and compensations
I ² C	Interface logic data I/O
NVM	Non-volatile memory
Register	Internal register
Self-Test Driver	Internal driver to generate self-test stimulus
SET/RST Driver	Internal driver to initialize magnetic sensor
Reference	Voltage/current reference for internal biasing
Clock Gen.	Internal oscillator for internal operation
POR	Power on reset



2 SPECIFICATIONS AND I/O CHARACTERISTICS

2.1 Product Specifications

Table 2. Specifications (Tested and specified at 25°C except stated otherwise.)

Parameter	Conditions	Min	Typ	Max	Unit
Supply Voltage	VDD	1.65		1.95	V
Standby Current	Total Current on VDD and VLOGIC		2		G
Low power consumption	10 Measurements/second		30		uA
Max output Data Rate of Continuous Mode	OSR2 setting	OSR2=010	200		Hz
		OSR2= 011	100		Hz
Sensor Field Range	Full Scale	-30		+30	Gauss
Sensitivity ^[1]	Field Range = ±30G		1000		LSB/G
Linearity	Field Range = ±30G Happlied=15G		0.5		%FS
Hysteresis	All Ranges		0.3		%FS
Offset			±10		mG
Sensitivity Tempco	Ta = -40°C~85°C		±0.05		%/°C
Digital Resolution			1.0		mGauss
Field Resolution	Standard deviation OSR2=011	X/Y axis	2		mGauss
		Z axis	3		
X-Y-Z Orthogonality	Sensitivity Directions		90±1		Degree
Operating Temperature		-40		85	°C
ESD	HB Model	2000			V
	CDM	500			

Note [1]: Sensitivity is calibrated at zero field, it is slightly decreased at high fields.

2.2 Absolute Maximum Ratings

Table 3. Absolute Maximum Ratings (Tested at 25°C except stated otherwise.)

Parameter	MIN.	MAX.	Units
VDD	-0.3	2.0	V
Storage Temperature	-40	125	°C
Exposed to Magnetic Field (all directions)		50000	Gauss
Reflow Classification	MSL 1, 260 C Peak Temperature		

2.3 I/O Characteristics

Table 4. I/O Characteristics

Parameter	Symbol	Pin	Condition	Min.	TYP.	Max.	Unit
Voltage Input High Level 1	V _{IH1}	SDA, SCL		1.0		1.8	V

Voltage Input Low Level 1	V _{IL1}	SDA, SCL		-0.3		0.45	V
Voltage Output High Level	V _{OH}	SDA	Output Current 7mA	1.2			V
Voltage Output Low Level	V _{OL}	SDA	Output Current 766 G(INT) Output Current 7s G (SDA)			0.3	V

3 PACKAGE PIN CONFIGURATIONS

3.1 Package 3-D View

Arrow indicates direction of magnetic field that generates a positive output reading in normal measurement configuration.

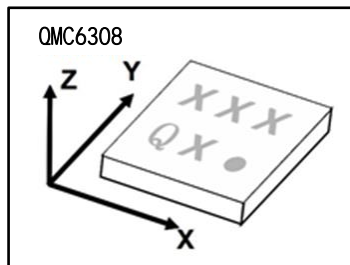

Figure 2. Package 3-D View

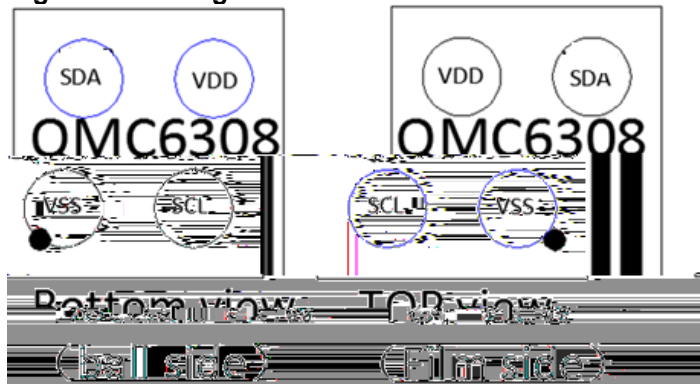

Figure 3. Package

Table 5. Pin Configurations

PIN No.	PIN NAME	I/O	TYPE	Function
A1	VSS		Power	Ground
A2	SCL	I	CMOS	I2C clock
B1	VDD		Power	Supply Voltage
B2	SDA	I/O	CMOS	I2C data

3.2 Package Outlines

3.2.1 Package Type WLCSP

3.2.2 Package Size:
0.8mm (Length)*0.8mm (Width)*0.5mm (Height)

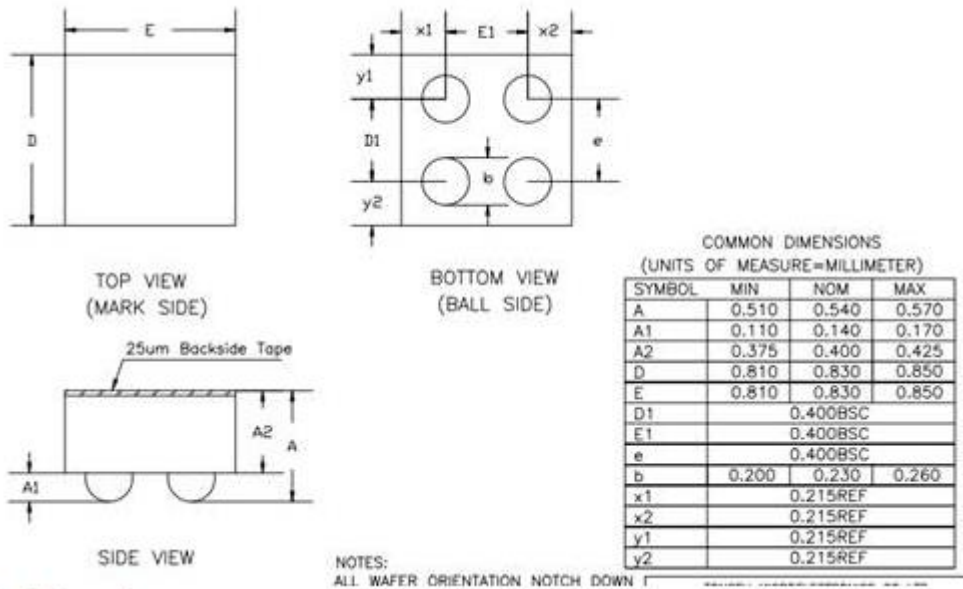

Figure 4. Package Size

3.2.3 Marking:
Tracking code:

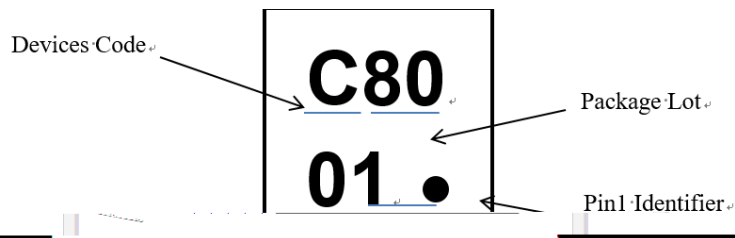

Figure 5. Chip Marking

4 EXTERNAL CONNECTION

4.1 Recommended external connection

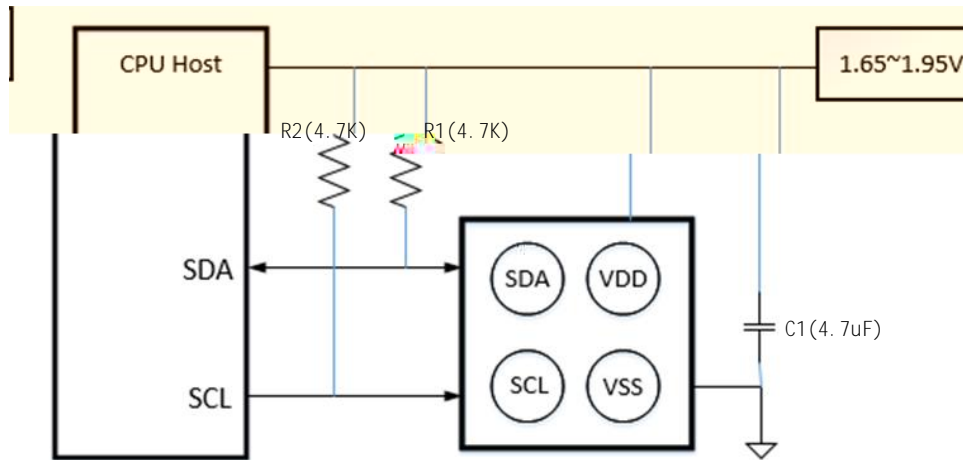

Figure 6. External Connection

4.3 Mounting Considerations

The following is the recommend printed circuit board (PCB) footprint for the QMC6308. Due to the fine pitch of the pads, the footprint should be properly centered in the PCB.

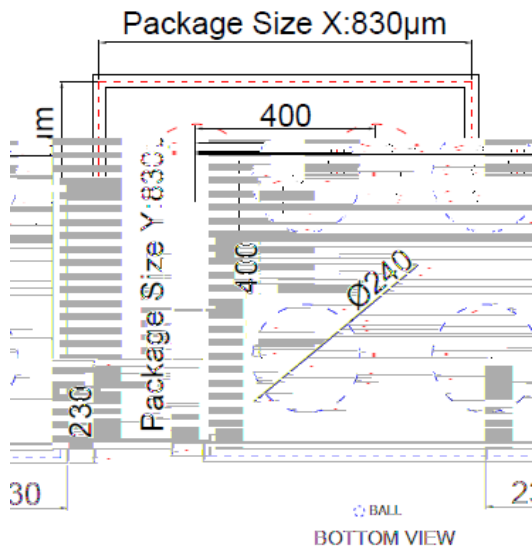

Figure 7. QMC6308 PCB footprint

4.4 Layout Considerations

Besides keeping all components that may contain ferrous materials (nickel, etc.) away from the sensor on both sides of the PCB, it is also recommended that there is no conducting copper line under/near the sensor in any of the PCB layers.

4.4.1 Solder Paste

A 4 mil stencil and 100% paste coverage is recommended for the electrical contact pads.

4.4.2 Reflow Assembly

This device is classified as MSL 1 with 260 C peak reflow temperature. Reference IPC/JEDEC standard J-STD-

Parameter	Symbol	Condition	Min.	Typ.	Max.	Unit
POR Completion Time	PORT	Time Period After VDD at Operating Voltage to Ready for I ² C Command and Analogy Measurement.			200	uS
Power off Voltage	SDV	Voltage that Device Considers to be Power Down.			0.2	V
Power on Interval	PINT	Time Period Required for Voltage Lower Than SDV to Enable Next POR	100			uS



Figure 8. Power On/Off Timing

5.4 Communication Bus Interface I²C and Its Addresses

This device will be connected to a serial interface bus as a slave device under the control of a master device, such as the processor. Control of this device is carried out via I²C.

This device is compliant with I²C Bus Specification. As an I²C compatible device, this device has a 7-bit serial address and supports I²C protocols. This device supports standard and fast speed modes, 100kHz and 400kHz, respectively. External pull-up resistors are required to support all these modes.

There are only one I²C address available. The default value is 2CH.

If more I²C address options are required, please contact factory.

5.5 Internal Clock

The device has an internal clock for internal digital logic functions and timing management. This clock is not available to external usage.

6 MODES OF OPERATION

6.1 Modes Transition

The device has three different modes, controlled by register (0x0A), mode bits Mode<1:0>. The main purpose of these modes is for power management. The modes can be transitioned from one to another, as shown below, through I²C commands of changing mode bits. The default mode is Suspend Mode.

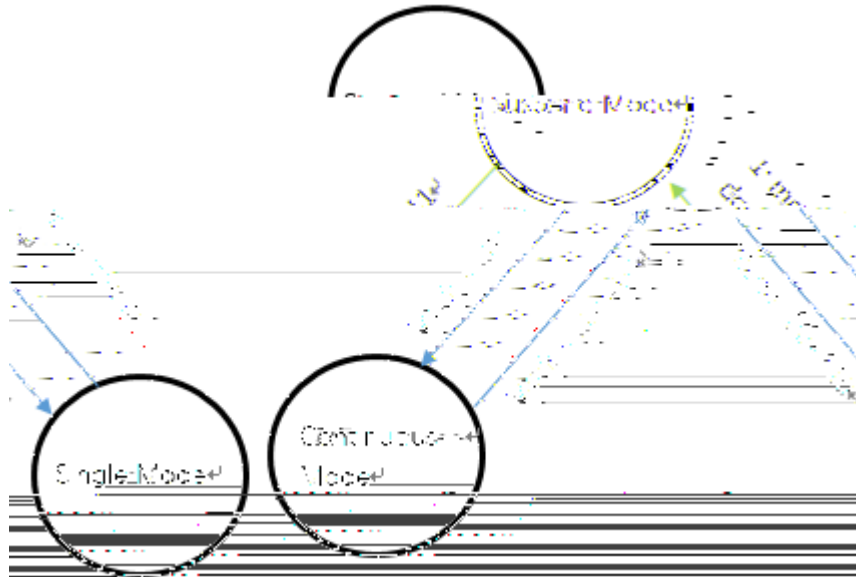

Figure 9. Modes Transition

6.2 Description of Modes

6.2.1 Continuous Mode

During the Continuous mode (MODE bits



8.2 I²C R/W Operation

8.2.1 Abbreviation

Table 9. Abbreviation

SACK	Acknowledged by slave
MACK	Acknowledged by master
NACK	Not acknowledged by master
RW	Read/Write

8.2.2 Start/Stop/Ack

START: Data transmission begins with a high to transition on SDA while SCL is held high. Once I²C transmission starts, the bus is considered busy.

STOP: STOP condition is a low to high transition on SDA line while SCL is held high.

ACK: Each byte of data transferred must be acknowledged. The transmitter must release the SDA line during the acknowledge pulse while the receiver must then pull the SDA line low so that it remains stable low during the high period of the acknowledge clock cycle.

NACK: Onk ži kokx ukyt zv r down the SDA





ORDERING INFORMATION

Ordering Number	Temperature Range	Package	Packaging
QMC6308-TR	-40°C ~ 85°C	WLCSP	Tape and Reel: 5k pieces/reel

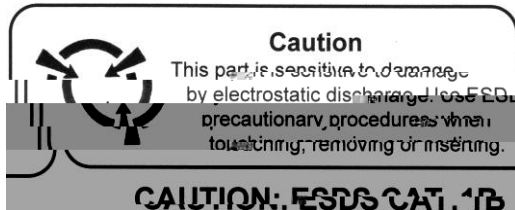

FIND OUT MORE

For more information on QST y Sgrt kzc Sensors contact us at 86-21-69517300.

The application circuits herein constitute typical usage and interface of QST product. QST does not provide warranty or assume liability of customer-designed circuits derived from this description or depiction.

QST reserves the right to make changes to improve reliability, function or design. QST does not assume any liability arising out of the application or use of any product or circuit described herein; neither does it convey any license under its patent rights nor the rights of others.

U.S. Patents 4,441,072, 4,533,872, 4,569,742, 4,681,812, 4,847,584 and 6,529,114 apply to the technology described.

China Patents 201210563667.3, 201210563956.3, 201210563952.5, 201210563687.0, 201310403912.9, 201410027189.3, 201410027240.0, 201410027085.2 and 201410085278.3 apply to the technology described.